

Easier to use the World Standard CNC from FANUC

FANUC

Series *0i*-MODEL F Plus



FANUC's New World-Standard CNC

FANUC Series **Oi-MODEL F PI**

More powerful and easier to use

Mach
Perfor

- Renewed design
- Equipped with **iHMI**
- Equipped with FANUC's latest CNC and servo technologies
- Comes standard with customizability functions
- Extended memory capacity

Reduced cycle

▶ Fast Cycle-ti

Achieves high-

▶ Fine Surface



Prevent sudden machine downtime with preventive maintenance

▶ Extensive failure prediction functions

Reduce recovery time by easily pinpointing faulty parts

▶ Diagnosis/maintenance functions

Minimizing
Downtime

us

improving performance

time to machine Technology

quality machining Technology

Two-product line-up covering different purposes

CNC for Machining Center

FANUC Series Oi-MF Plus

- 1 path system total controllable axes: up to 9
- 2 path system total controllable axes: up to 11
- Simultaneous controlled axes : up to 4 axes

CNC for Lathe

FANUC Series Oi-TF Plus

- 1 path system total controllable axes: up to 9
- 2 path system total controllable axes: up to 12
- Simultaneous controlled axes : up to 4 axes

(Total number of controlled axes: total of feed axes and spindles)



Ease of Use

Integrated support of the shop floor
▶ **FANUC iHMI**

Original screen for ease of use
▶ Comes standard with customizability functions

IoT integration
▶ Extensive compatibility with field networks

System configuration

CNC control unit (LCD mounted type/stand-alone type)

Line-up of displays that are compatible with the various types of machine tools, from compact to large and standard to high-spec, such as the PANEL *i*H/*i*H Pro compatible with *i*HMI and the compact 10.4" LCD/MDI unit.



PANEL *i*H Pro 21.5" PANEL *i*H/*i*H Pro 15" PANEL *i*H/*i*H Pro 10.4"



10.4" LCD/MDI

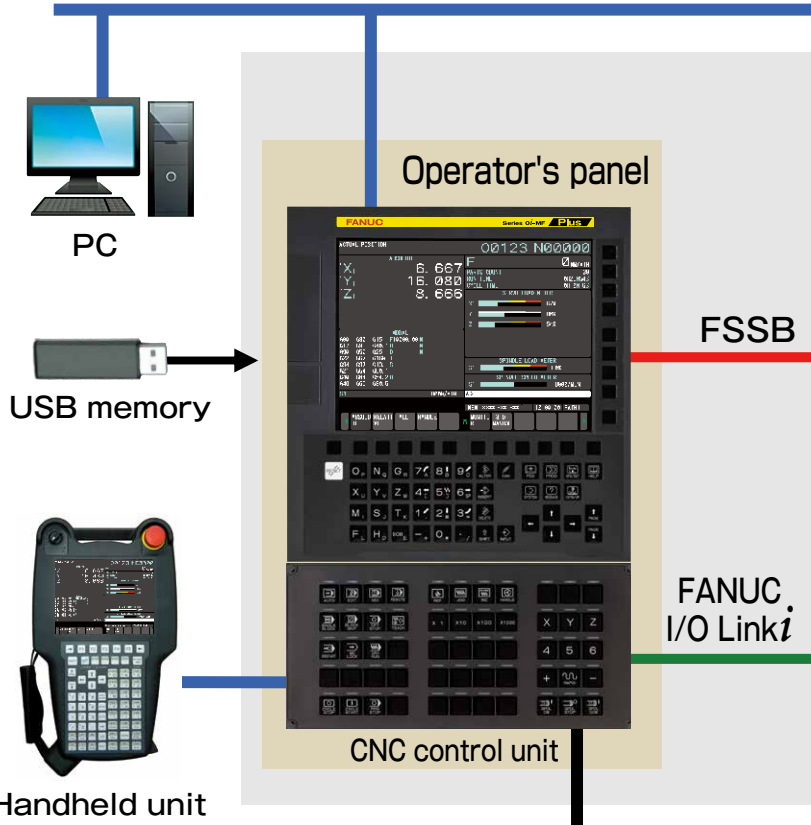

Handheld unit

Equipped with an emergency stop button and a manual pulse generator, this handy unit line-up achieves safe manual operation of machine tools.



*i*Pendant

Handy Machine Operator's Panel

Portable manual pulse generator

I/O Unit

Wide range of I/O units compatible with various installation locations and I/O devices.

Optimized for operator's panels with its thin and space-saving design

Standard operator's panel with key input duplication

Handles the output/input of safety signals

Compatible with original operator's panels



Safety Machine operator's panel



I/O module for operator's panel supporting safety function



I/O module for operator's panel

Optimized for power magnetics multi-point output/input type

Excellent cost performance with multi-point output/input

Compact and with reduced wiring



I/O unit for power magnetics cabinet



I/O module for connector panel

Ethernet

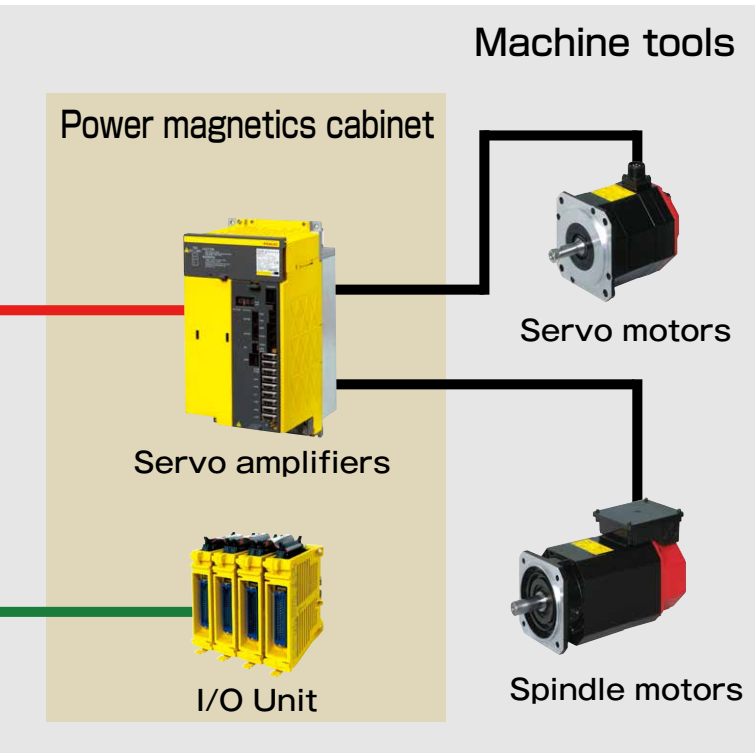

Servo motor

Line-up to meet the various needs of machine tools and contribute to the performance improvement of feed axes



AC SERVO MOTOR
 α i-B/ β i-B series



DD MOTOR
DiS-B series

Spindle motor

Line-up to meet the various needs of machine tools and contribute to the performance improvement of spindles



AC SPINDLE MOTOR
 α i-B/ β i-B series



BUILT-IN SPINDLE MOTOR
Bi-B series

Peripheral equipment

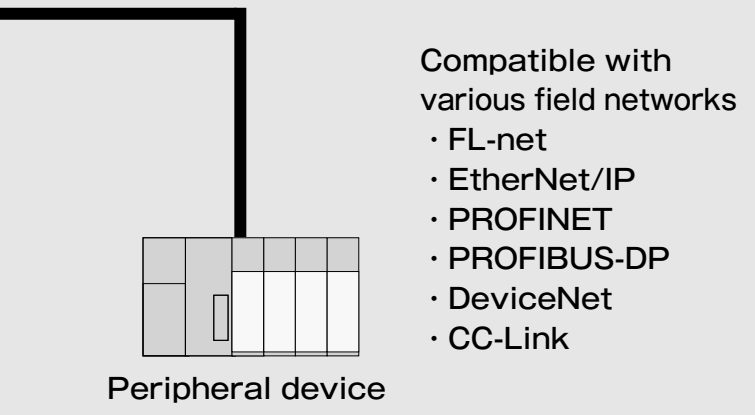

Servo amplifier

Line-up to be flexibly available for a variety of machine tools and contribute to the downsizing of cabinets



SERVO AMPLIFIER
 β iSVSP-B series



SERVO AMPLIFIER
 α i-B series

cabinets with high scalability and extensive modules such as the and the analog/digital output/input module

Reduced wiring work with a dismantlable pole terminal block



Terminal Type I/O module

Monitor machine status with the temperature sensor and the shock sensor



MULTI SENSOR I/O UNIT

Extensive modules including analog, temperature input, and high-speed counter



I/O Unit-MODEL A

Optimized for reduced wiring by enabling distributed setup

Can be positioned near sensors scattered inside and outside the machine cabinet

IP67 type



I/O Unit-MODEL B

High performance

Reduced cycle time

Fast Cycle-time Technology

Fast Cycle Time Technology refers to CNC and servo technologies that achieve reduced cycle times. It reduces cycle times of machining programs through methods such as accelerating and decelerating depending on the operational state, making the best use of spindle performance, and reducing the sequence processing time for external signals.

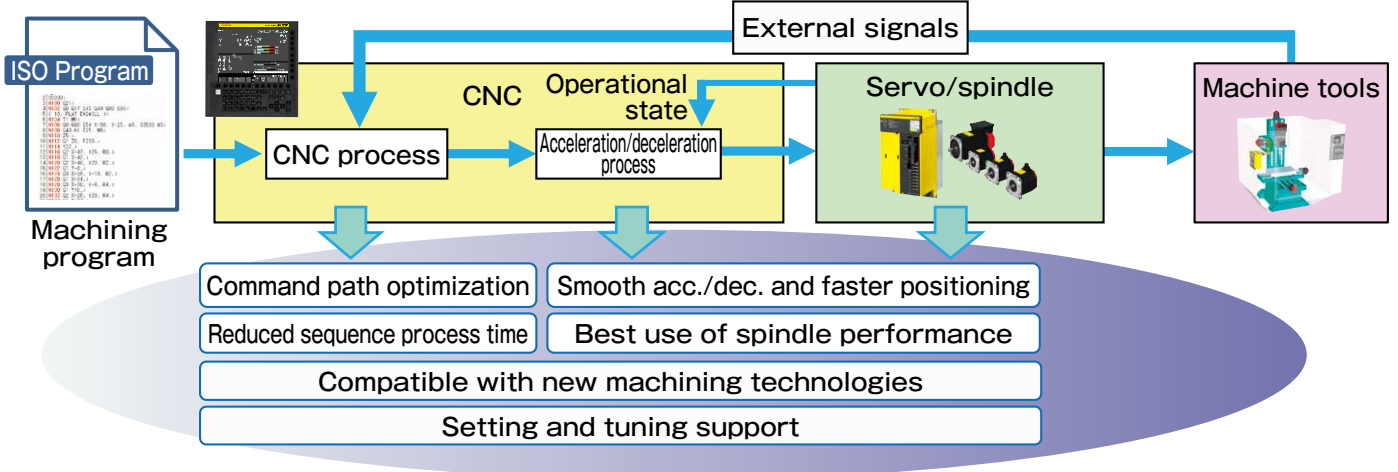

Fast Cycle-time setting

Easily reduce cycle times

The Fast Cycle-time setting compares the currently set parameter setting to the FANUC default setting, allowing you to easily use the setting that most effectively reduces cycle time.

FAST CYCLE TIME SETTING		
PARAMETER	STANDARD	
T2 USED FOR BELL-SHAPED ACC/DEC	48	25 usec
DEC. RATIO IN RAPID TRAVERSE OVERLAP	0	30%
DEC. RATIO IN THREADING CYCLE OVERLAP	0	10%
SERVO LOOP GAIN	4000	5000 (0.61/sec)
IN-POSITION WIDTH	0.200	0.100 mm
VELOCITY CONTROL METHOD	1	1
FFR-FORWARD FINISHING	0	1
VELOCITY LOOP HIGH CYCLE MANAGEMENT	1	1
VELOCITY FEED-FORWARD COEFFICIENT	0	100%
FEED FORWARD COEFFICIENT	0.00	50.00%
VELOCITY GAIN OVERRIDE FOR CUTTING	200	150%

No. 1621 TIME CONSTANT T2 USED FOR BELL-SHAPED ACC/DEC IN RAPID TRAVERSE;
SPECIFY TIME CONSTANT T2 USED FOR BELL-SHAPED ACCELERATION/ DECELERATION IN RAPID TRAVERSE FOR EACH AXIS.

Reduced cycle time example:
Workpiece for evaluation

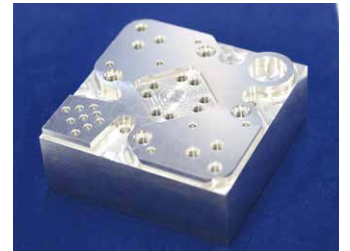

Before application 4 minutes 47 seconds
After application 4 minutes 4 seconds
Approx. 15% reduction

Smart Servo Control

Smart Servo Control is a group of functions to optimize control in real time according to the change of machine conditions such as load and temperature. These functions

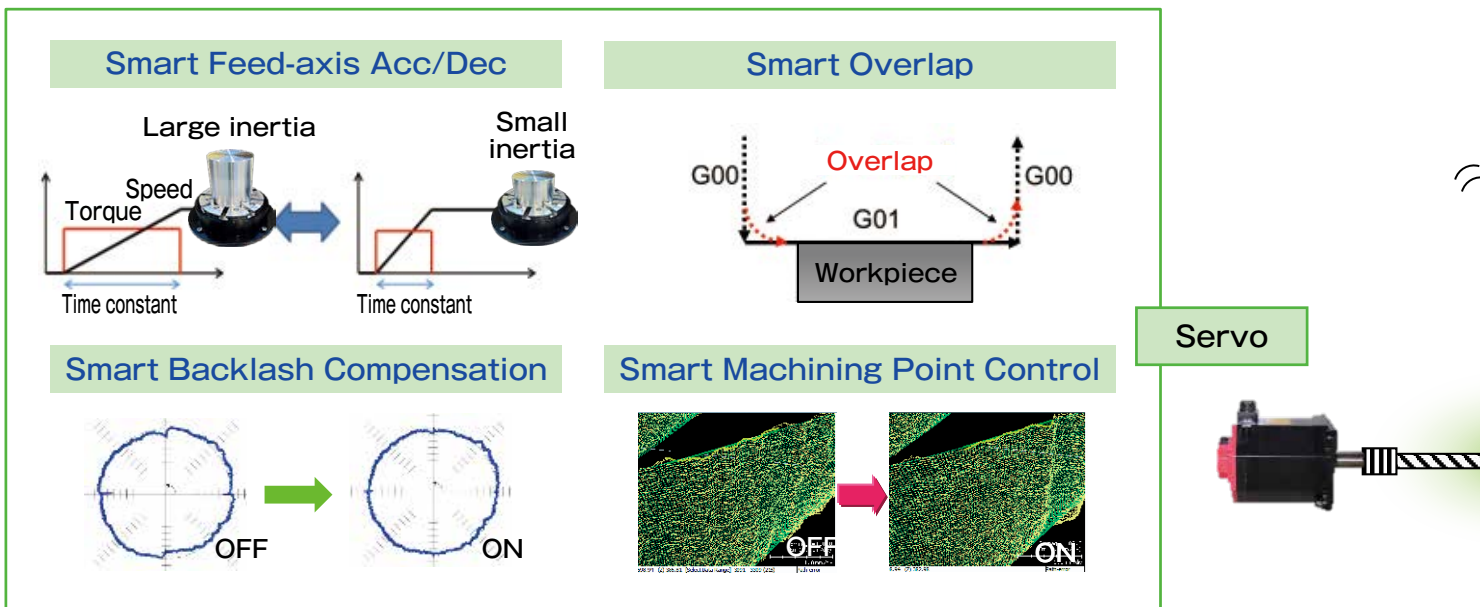

High-Speed, Fine Surface Machining

Fine Surface Technology

Fine Surface Technology is a collective term for CNC and servo technologies that achieve fine surface machining. Fine Surface Technology allows for the interpolation of high precision machining program output from CAD/CAM, high-speed execution of small segment programs, the generation of a smooth tool path and accurate command follow-up.

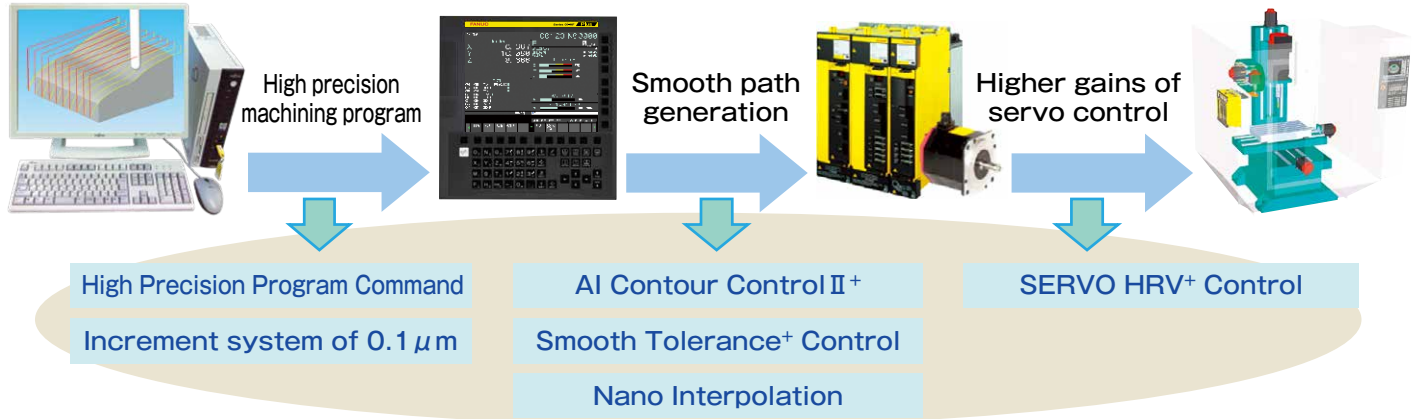

Smooth Tolerance⁺ Control

Smoothing continuous small blocks to realize fine surface machining

The machining path specified in continuous small blocks, like the one for mold machining, is smoothed out within the specified allowance error tolerance.

The smooth machining path reduces mechanical shock and improves the quality of the machined surface.

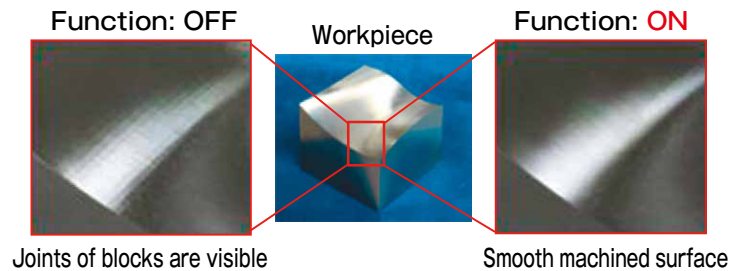

Joints of blocks are visible

Smooth machined surface

Fine Surface settings

A default setting value is prepared in accordance with machining conditions (roughing, semi-finishing, or finishing), and settings and adjustments can be made for high-speed, high-precision machining parameters that match each machine through easy operation using an intuitive slide bar. The parameters can be optimized by selecting a machining process on the machining program or through screen operation during machining.

contribute to high-speed, high-precision and high-quality machining as the control technology supporting Fast Cycle-time Technology and Fine Surface Technology.

The diagram illustrates four key control technologies for a spindle:

- Smart Rigid Tapping:** Shows a tapping process with a graph of spindle speed and torque over time, indicating the tapping cycle.
- Smart Thermal Control:** A graph showing temperature rising over time. It indicates an **OH alarm temperature** threshold. The system can be set to **OFF** (allowing temperature to rise) or **ON** (preventing temperature from reaching the alarm level).
- Smart Spindle-load Control:** A graph showing **Feed speed**, **Load**, and **Temperature** over **Time**. It highlights an **Over heat level** threshold.
- Smart Load Meter:** Shows a digital display with values like 0, 223, 189% and **DURATION TIME 9 S**. It is associated with **Smart Spindle Acc/Dec** control.

FANUC *i*HMI

FANUC *i*HMI supports all jobs at shop floor consistently, exceeding a limit of conventional CNC operation. In FANUC *i*HMI, the functions required for each of processes, "plan", "machining", and "improvement", performed in a shop floor, are put into an integration screen called home. The functions can operate in cooperation with one another.

FANUC *i*HMI provides not only functions related to display and other operations, but also performance as a thin client including a function which uploads various types of information related to machining to the upper-level system in the network and a function which shares information accumulated in the database in the upper-level system. FANUC *i*HMI will act as a platform which plays core roles in the IoT introduced for machine tools.



HOME screen

Tool manager

- Tool manager consolidates tool information required by a shop floor.
- This function reads tool data provided by tool manufacturers. The data can be used for CNC machining and FANUC *i*HMI applications.
- This function manages tool information provided by tool makers, such as mold model number, dimensions, and machining conditions.

CNC operation

- The CNC operation screen significantly improves operability by integrating three operations: programming, set-up, and machining.
- The operation system along the flow of operations enables easy-to-understand operation.
- Programming errors can be detected before running the program by using the machining simulation function.
- The help, troubleshooting, and other functions are available to solve problems at a time if you have difficulty.

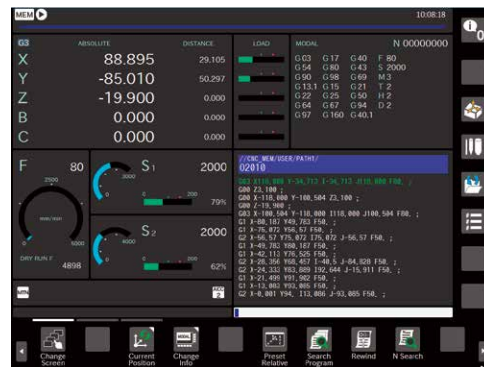

CNC operation screen

Data logger

- Data logger periodically collects various types of CNC data.
- The collected data can be used by FANUC *i*HMI applications.
- The data can also be accessed via a network.

Maintenance manager

- Maintenance manager monitors the status of each service part and notifies you of an alarm before the part gets out of order.
- This function supports inspection and replacement with manual display.
- In addition to CNC parts, the function can also monitor mechanical parts.

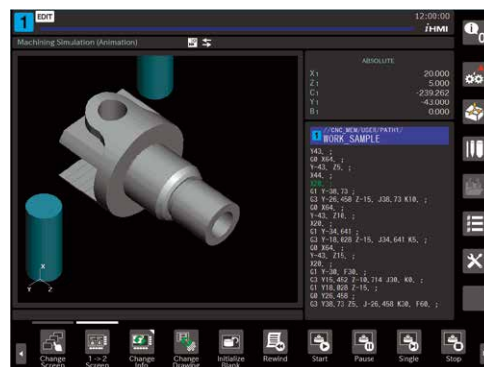

Machining simulation function

SERVO VIEWER

- SERVO VIEWER offers the waveform display of the machine operation such as position of feed axes and torque of spindle.
- PMC signals and sequence numbers can be observed simultaneously.
- Useful for reducing cycle time and improving cutting condition.



SERVO Viewer

Renewed design

A new, easy-to-use, dark-themed screen was designed by renewing the color scheme of the screen and by employing a hierarchical display of soft keys using icons on a flat exterior display device with a black tone.

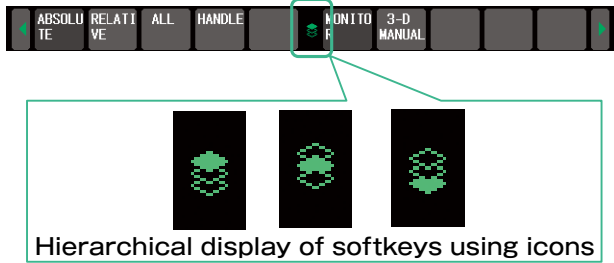

10.4" LCD/MDI and a renewed operation screen

Easily use memory cards as high-capacity program memory devices

Improvement of memory card program operation editing

The memory card (compact flash card) installed in the card slot of the display device can be used as a portable high-capacity program memory device.

- By operating the CNC screen, you can create a maximum of 2 GB program memory on the memory card.
- You can transfer programs to memory cards using the FANUC Program Transfer Tool or USB memory.
- Programs on the memory card can be edited on the CNC screen.
- Programs on the memory card can be operated automatically using Memory Mode.

FANUC Program Transfer Tool

FANUC Program Transfer Tool is a software tool for transferring part programs and data by connecting PC and CNC via Ethernet. Files in the CNC program memory are displayed on the tool in an easy-to-understand way, so input/output operation can be easily performed with a mouse.

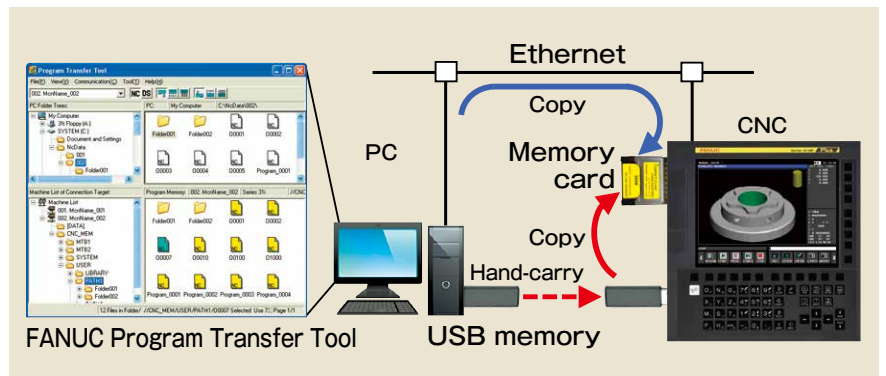

FANUC MANUAL GUIDE *i*

MANUAL GUIDE *i* is an integrated operation guidance, which provides easy operation guidance from programming through machine operation on one single screen. It can be used for lathes and machining centers.

- Integrated operating screen
- Powerful program editing functions
- Various machining cycles
- Realistic machining simulation
- Set-up guidance

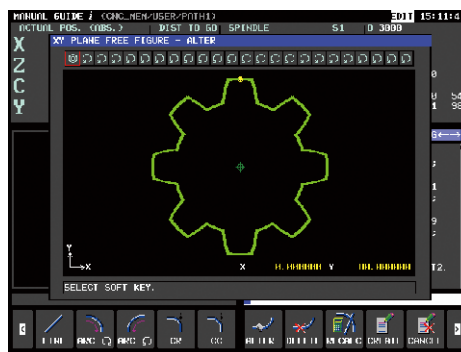

Free figure input screen

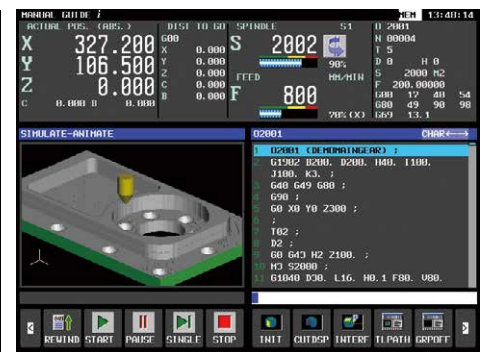

Machining simulation screen

Many Customizable Functions

Ease of Use

Customizable functions are available, which allow machine tool builders to customize their own machine tools

Customizing operation screens

FANUC PICTURE

This tool enables you to create a machine operation screen simply by pasting screen components such as buttons and lamps on the PC.

- The screen creation tool is FANUC's proprietary easy-to-use user interface that is optimized for creating screens for CNCs.
- Screens that are created can be displayed and operated on various CNC models.
- Complicated controls such as network communication and file control can be easily implemented by using general-purpose scripts.

In addition, in the PANEL ν series display device, it is possible to create screens that leverage the performance of display devices.

- You can display the font for each language of any desired size.
- You can display buttons, lamps, and high precision images in full color.

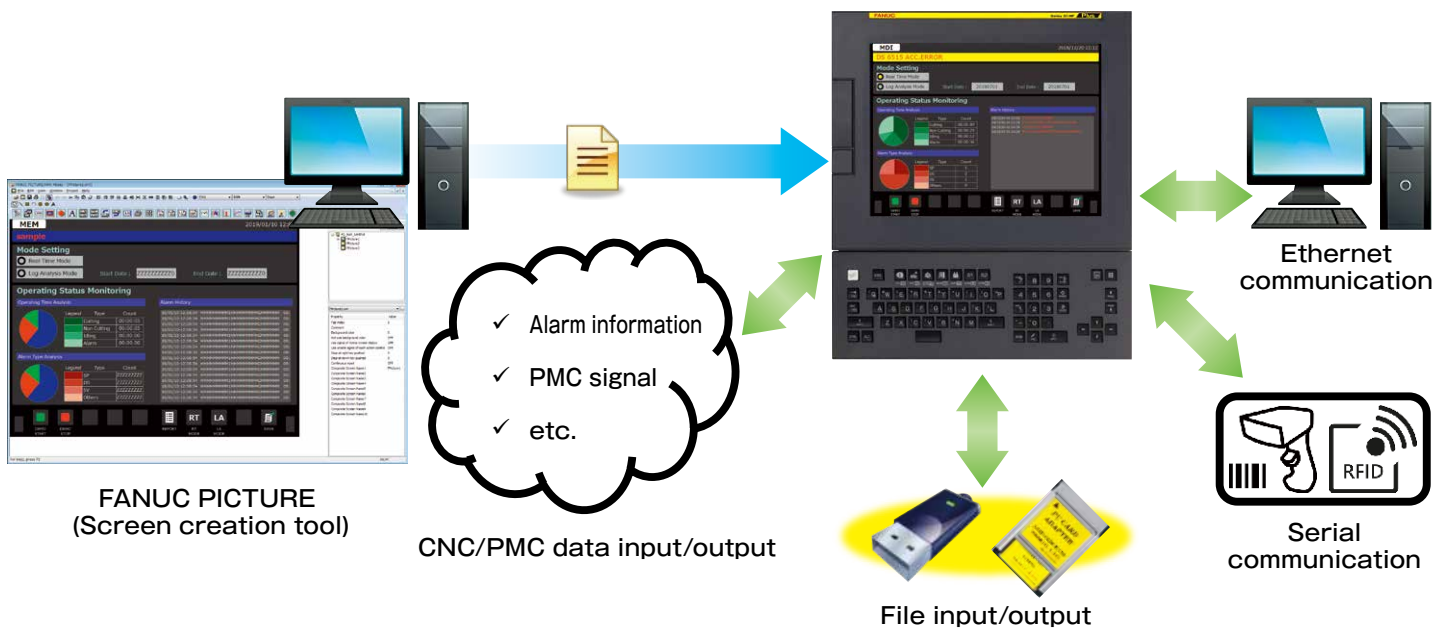

C Language Executor

Machine tool builders can create their own operation screens, which enables unique CNC display and operation.

- C language is used for programming.
- Multi window display enables creation of pop-up menus.
- Operation screens using the touch panel can be created.
- In addition to standard ANSI functions, many functions are available for CNCs and PMCs.
- High-level tasks to which high execution priority is assigned can monitor signal and position information.



Implementing original sequence control based on PMC

FANUC LADDER-III

For machine customization, a machine tool builder's own sequence control can be incorporated into the built-in PMC. A PMC sequence program can be created on a personal computer by using FANUC LADDER-III, a very easy-to-use programming tool with many useful functions.

- A program can be created with ladder and function block.
- A program can be coded using signal names instead of signal addresses.
- Online monitoring and editing can be performed by connecting a personal computer with the CNC via Ethernet.
- Including PMC Function Library which enables you to integrate functions such as PMC axis control easily.

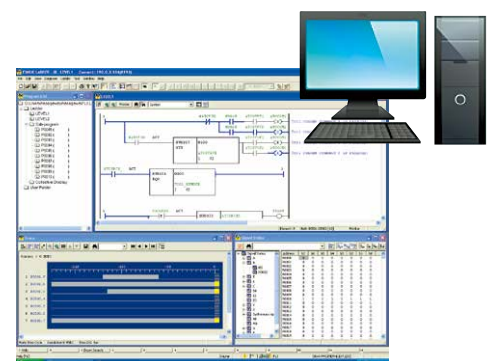

PANEL *i*H / *i*H Pro achieves the usability of PCs in CNCs

Convenient platform with useful functions (e.g. high-speed graphics, large memory, etc.) can be added on CNC.

- Remote desktop function improves convenience of CNC by enabling operation of the PC connected via Ethernet from CNC. (e.g. operating the CAD/CAM, referencing the manual, etc.)
- Making memory operation easier to use by using large capacity storage

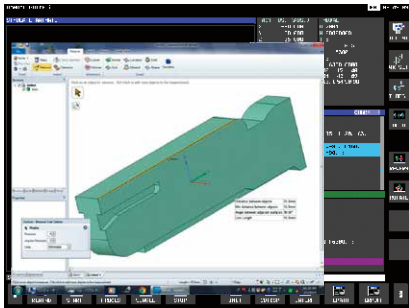

Remote desktop function
Operating the PC connected via Ethernet from CNC



Memory operation with large memory

Set-up Guidance Function

Measurement is achieved by touching the tool to the work manually. And the measurement value can be set to the work coordinate system. As a result, the arrangements time can be greatly reduced.

- Single surface measurement
- Outside diameter measurement
- Inside diameter measurement
- Outside width measurement
- Inside width measurement
- Measurement of corner outside
- Measurement of corner inside
- Angled work measurement



Function for Loader Control

Loader control can be easily achieved at low cost. This function can contribute to the automation of machine tools. Loader can be controlled by the same G codes as those of machining programs. There is no need to control an axis by the PMC ladder, etc. Loader programs can be executed independently of machining programs.

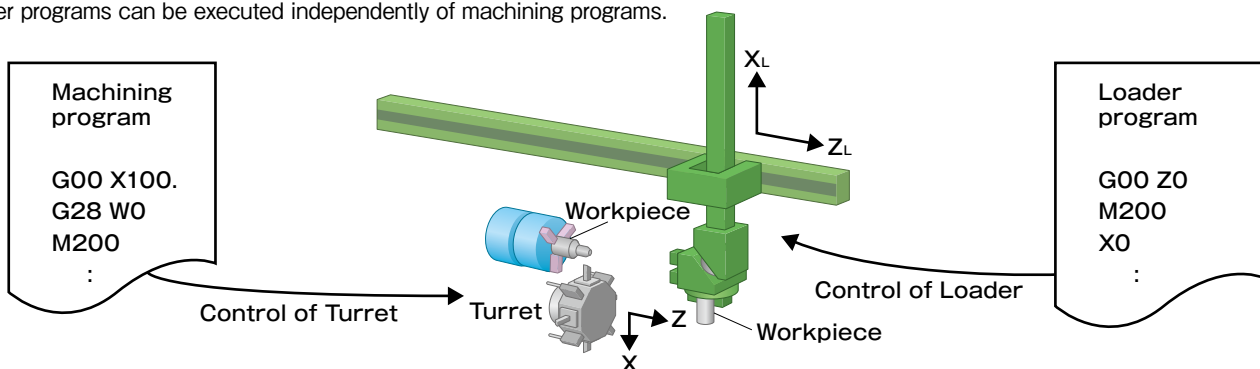

Support for adding sensors and peripheral devices

Multi C Language Executor

New custom screens can be easily added without changing the custom screens implemented in the machine (created with FANUC PICTURE or C language Executor).

Ladder Dividing Management Function

Ladders for controlling sensor or peripheral equipment can be added without changing the ladder for machinery control already implemented in the machine.

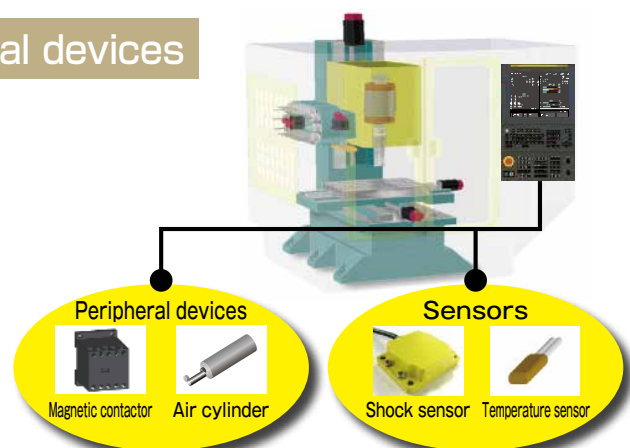

Network Support Functions

Ease of Use

Advancing the IoT adaptability of CNC machine tools with extensive network functions

Ethernet / Industrial Ethernet / Field Network

You can use Embedded Ethernet provided as standard and Fast Ethernet with a communication dedicated processor for NC program transfer and remote maintenance.

Various types of Industrial Ethernet and Field Networks are supported to enable various types of peripheral devices to be connected for controlling peripheral devices such as waterproof I/O devices and collecting sensor information. Via a MULTI SENSOR I/O UNIT or other devices, information of impact, temperature, and other sensors can also be read.

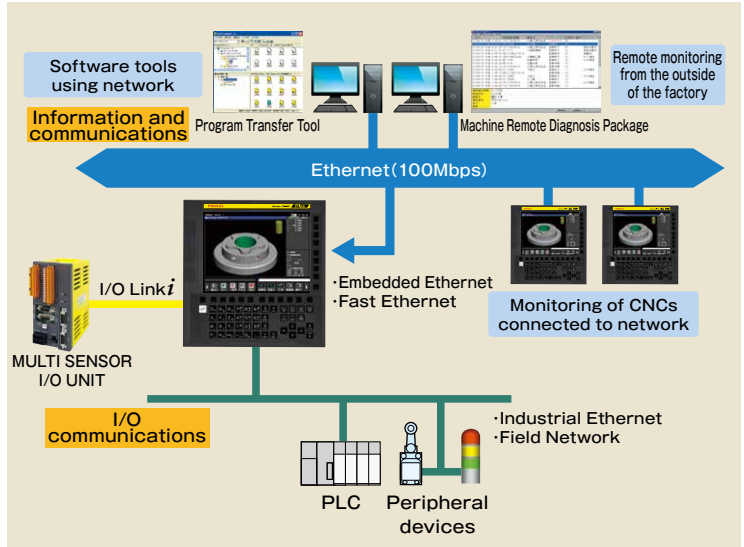

Supported Industrial Ethernet/Field Networks

- FL-net
- EtherNet/IP (master/slave)
- PROFINET (master/slave)
- PROFIBUS-DP (master/slave)
- DeviceNet (master/slave)
- CC-Link (slave)
- Modbus/TCP (slave)

FANUC MT-LINK*i* (Operation Management software)

MT-LINK*i*

MT-LINK*i* is a software product that can collect, manage, and help visualize various information of machines connected via Ethernet. It helps visualize the machines in factories, and contributes to minimizing downtime.

- It can collect device information not only from machine tools equipped with FANUC CNCs, but also from FANUC robot controllers, OPC-compatible PLCs, and MTConnect-compatible machine tools.
- Information of existing devices that do not have Ethernet I/F can also be collected by using an Ethernet I/O converter.
- Many standard screens that display various pieces of information such as the operational states and operational results of machines are available.

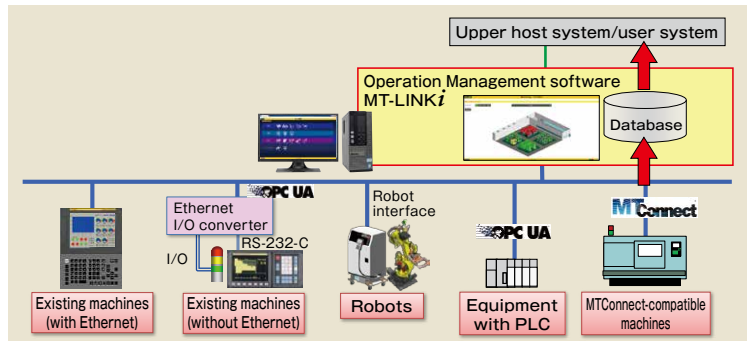

Standard screen example)



Overview screen



Operational results screen

Visualization of machine operation

By using MT-LINK*i* together with SERVO VIEWER, servo data and various status signals are collected, achieving the visualization of detailed machine operations.

- High-speed sampling (1ms) servo data is efficiently collected from multiple machine tools.
- Various schedule and trigger functions enable efficient analyses by collecting only required data at the right timing.

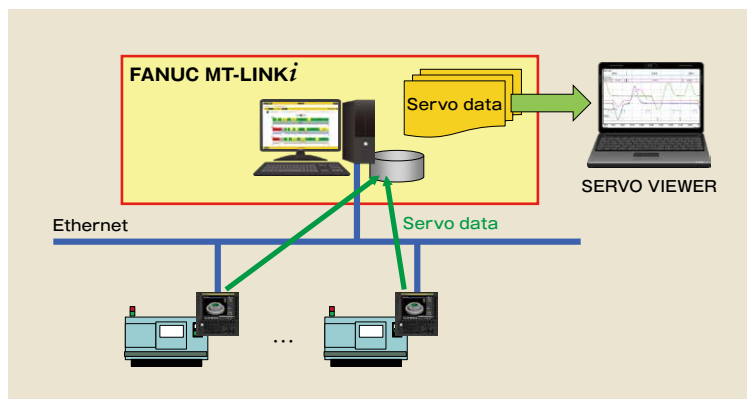

High-Speed, Large Capacity, and Multi-path PMC

High-Speed and Large Capacity

The integrated PMC now achieves even higher speeds. Large-scale sequence controls can be processed at high speed using the powerful dedicated processor and the latest custom LSI.

- Program capacity Max. 100,000 steps (Total of all PMC paths)
- Internal relay (R) Max. 60,000 bytes
- Data table (D) Max. 60,000 bytes
- PMC paths Max. 3 paths (Max. 16 ladder programs)

Multi-path PMC

One PMC can execute up to three independent ladder programs, including loader control and peripheral equipment control.

- Ladder programs can easily be developed according to each user's machine configuration.
- Cost reductions are achieved by eliminating external PLCs or other devices for peripheral equipment control.

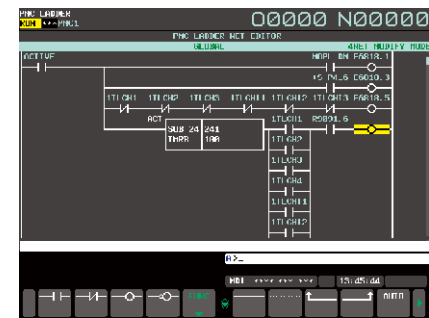
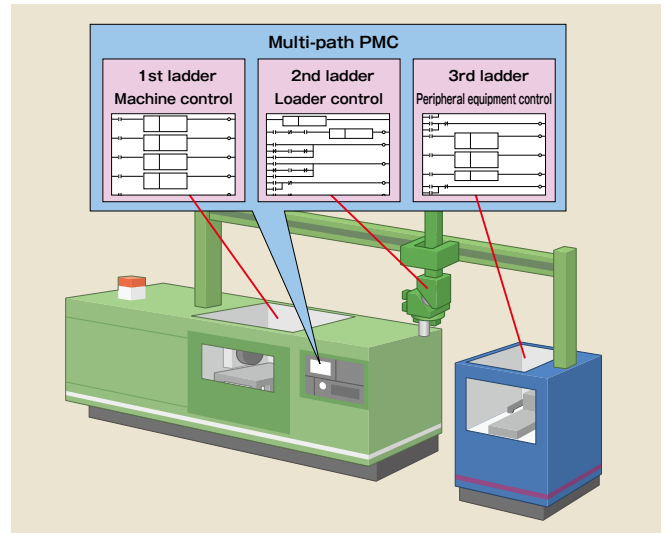

CNC integrated ladder editing function

Easy ladder program development

- Monitor display, editing, and debugging for ladder programs can be conducted on the CNC screen.
- Repeatedly used ladder circuit patterns can be easily reused in function blocks.
- Many different types of instructions including floating-point operations and functional instructions that handle text strings are now available.
- The PMC Function Library attached to FANUC LADDER-III provides functions that can be immediately implemented, such as PMC axis control and peripheral equipment control, which can be freely customized.

Safety functions

Improvement of the safety of machine tool and machining line

Dual Check Safety Function

This is a safety function integrated into the CNC that conforms to ISO 13849-1 PL d. Multiple processors perform dual monitoring of the actual positions, speed, and safety-related I/O of servo motors and spindle motors, securing a high level of safety by providing duplicated paths for cutting off power.

Network safety function

By combining this function with the Dual Check Safety function, safety functionality of the machining line is achieved.

- Safety function by FL-net
- EtherNet/IP Adapter Safety function
- PROFINET IO Device Safety function

Safe Torque Off (STO) function

This is a safety function integrated in servo amplifiers that conforms to IEC 61800-5-2.

Motor power can be safely cut off by the duplicated cut-off path within the amplifier.

Dual Check Safety Function

- The machine can be operated safely while the protective door is open

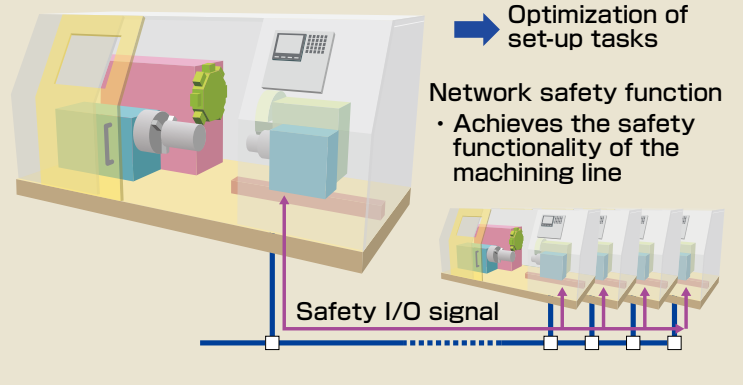

Functions for minimizing downtime

Contribution to Preventive Maintenance

Leakage Detection Function

In a harsh environment of a cutting coolant, the coolant may infiltrate into a motor and the machine may stop suddenly due to the insulation deterioration.

The Leakage Detection Function built into the amplifier automatically measures the insulation resistance of motors, and detects the insulation deterioration before the machine leads to stop, enabling preventive maintenance.

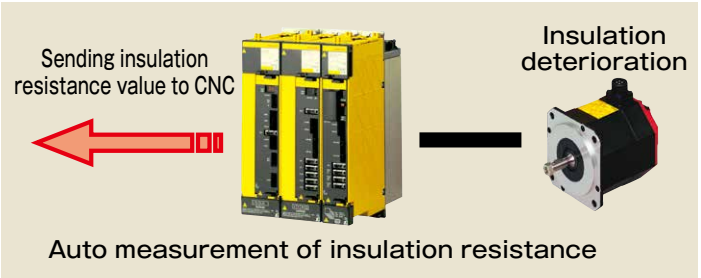

Cooling Fan Warning Function

By monitoring a decrease in the rotational speed of each cooling fan motor of the CNC and the servo amplifier, signs of fan abnormalities can be detected. This function enables preventive maintenance.

Fans are stored in a cartridge and can be replaced quite easily, so maintainability is enhanced.

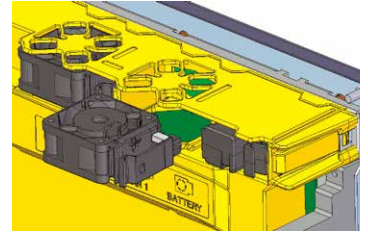

Failure Part Detection

Trouble Diagnostic Function

Various failure detection functions provided to the I/O Link *i* and FSSB can detect interruptions in the power supply to the I/O modules or servo amplifier and identify disconnection locations of the communication cable.

In addition to that, I/O Link *i* can detect the ground fault of each DO.

The trouble-shooting function enables you to see diagnosis information helpful in determining the status when an alarm occurs on the CNC screen.

- Trouble-shooting guidance screen
- Trouble-shooting monitor screen
- Trouble-shooting graph screen

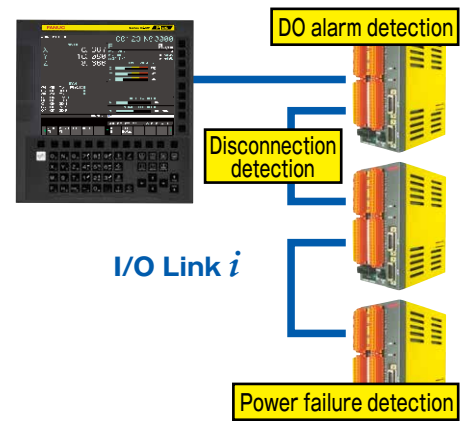
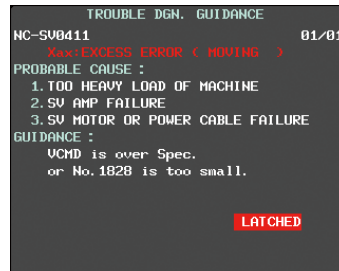

Encoder Communication Check Circuit

This check circuit enables a quick recovery from encoder communication alarm by identifying which part such as encoder, feedback cable or servo amplifier has failed.



Prevent Machine Damage at Power Failure

Machine Protection at Power Failure

Damage of machines and workpieces at power failure is prevented where a power supply is unstable or in a lightning-prone areas.

- **Gravity-axis drop prevention**
The holding brake of gravity axis are quickly activated by detecting power failure in the circuit incorporated into the amplifier.
- **Stop distance reduction*1)**
Feed axes are quickly stopped to avoid a crash in high-speed machine tools.
- **Retraction*2)**
The tool is retracted from the workpiece while keeping synchronization in gear cutting machines and others.

*1), *2) "Power Failure Backup Module (Hardware)" or "Power Failure Backup Function (Software)" shall be applied.

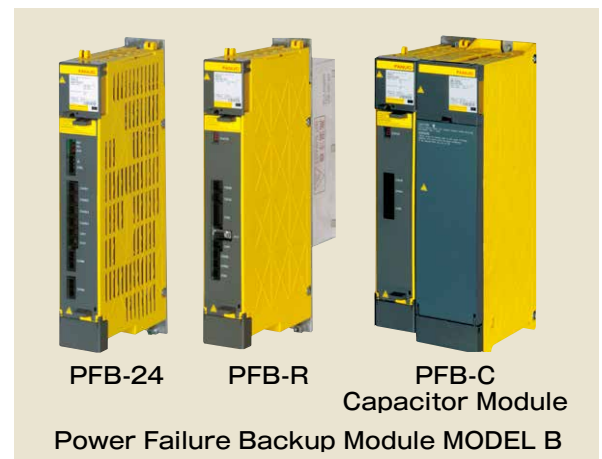

Powerful Software Tools

Providing support for the development projects of machine tool builders

FANUC CNC GUIDE

Software tool "FANUC CNC GUIDE" which simulates CNC operations on a PC to fully utilize the ever advancing CNC functions. The software tool can be used for development and educational purposes.

- CNC GUIDE
- CNC GUIDE Academic Package

CNC GUIDE

Development and debugging custom screens and ladder programs can be effectively performed on the PC. Because you can actually debug on a PC in the office before changing the customized software for the actual machining tool, it will improve efficiency of development work.

- FANUC PICTURE
Checks behavior of the operation screen created with FANUC PICTURE on the CNC GUIDE
- C Language Executor
Checks behavior of C language program for CNC by compiling it for PC
- PMC Simulation
Simulation of the ladder program performed on the PC
Supports various functions such as Multi-path PMC and Function Block



CNC GUIDE and FANUC PICTURE

CNC GUIDE Academic Package

Can perform operation training of CNC/MANUAL GUIDE *i* on the PC. It is possible to train operation without using the actual machining tool. We provide materials for classroom use for 16/32 students and self-study at home for 1 or 3 years.

- Operation in MEM and MDI mode/Automatic operation
- Editing the machining program and machining cycle in EDIT mode
- Use of macro variables and system variables
- Operation by calling sub-program and DNC
- Displays the same alarm as the machine at the time of error
- Machining simulation (cutting animation, tool path drawing)



CNC operation training

Support of efficient servo tuning for high-speed and high-precision machining

FANUC SERVO GUIDE

FANUC SERVO GUIDE supports you to perform tuning of the servo and spindle in an integrated manner, including creating test programs, setting parameters and measuring data. You can use it easily by connecting a PC to a CNC directly. In addition to the motions of each servo axis and spindle axis, you can observe program execution status inside the CNC and PMC signals as waveform data and analyze the machine operation in detail. Continuous measurement for a long period is also possible.

Tuning Navigator offers automatic process for tuning gain, filter and others and enable you to perform the advanced servo tuning in a short time. The automatic tuning function for protrusion compensation significantly shortens the time of tuning for high-speed and high-precision.

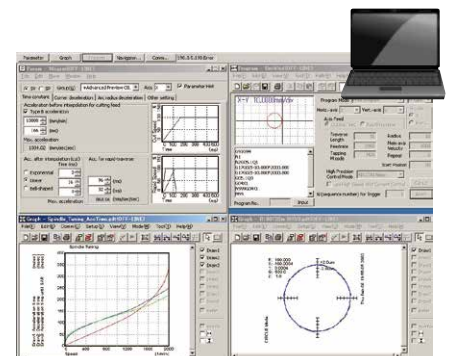

Maintenance and Customer Support

Worldwide Customer Service and Support

FANUC operates customer service and support network worldwide through subsidiaries and affiliates. FANUC provides the highest quality service with the prompt response at any location nearest you.

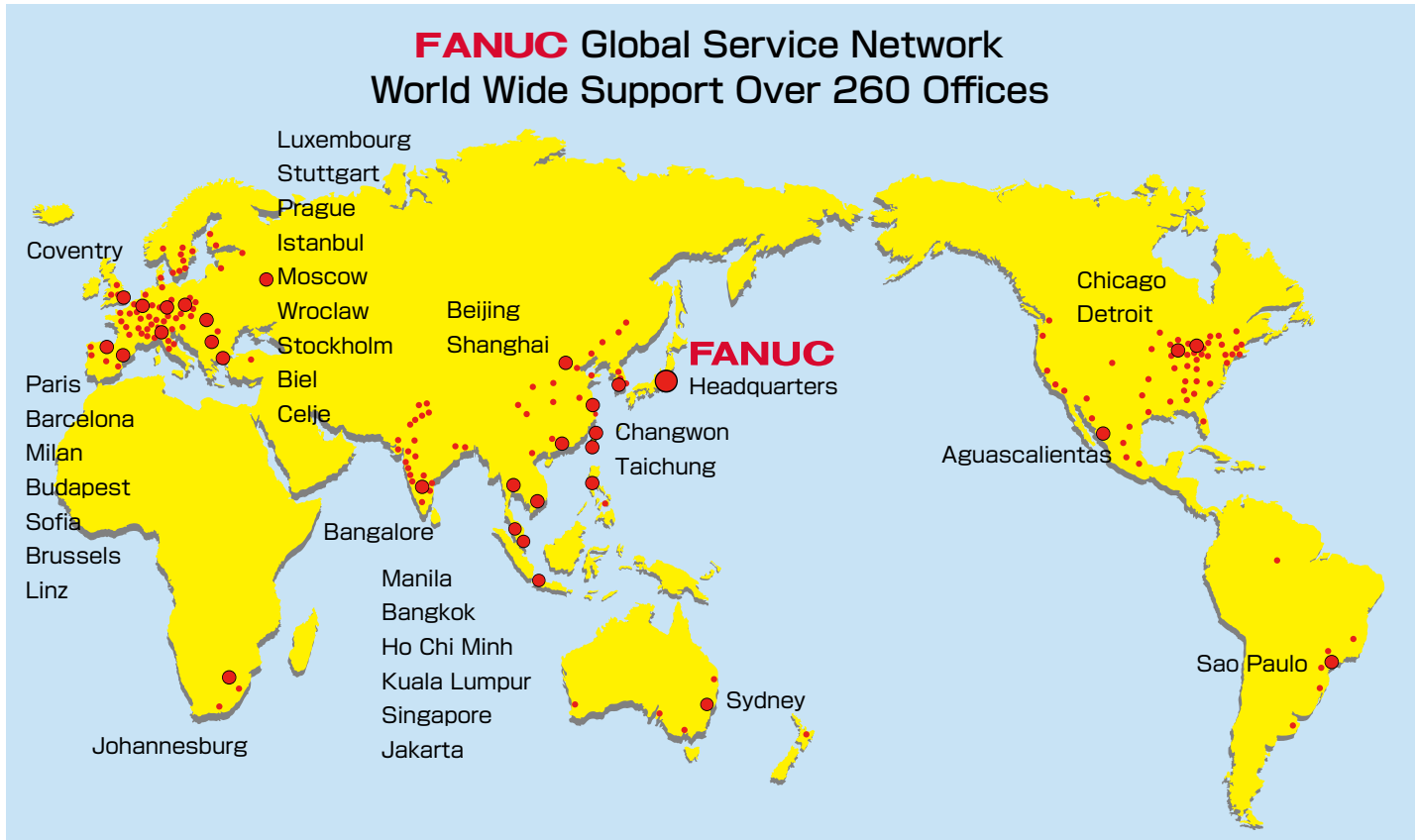

FANUC ACADEMY

FANUC ACADEMY operates versatile training courses to develop skilled engineers effectively in several days.

Inquiries : Oshino-mura, Yamanashi,
Japan 401-0597

Phone : 81-555-84-6030
Fax : 81-555-84-5540



FANUC CORPORATION

•Headquarters Oshino-mura, Yamanashi 401-0597, Japan
Phone: 81-555-84-5555 Fax: 81-555-84-5512 <http://www.fanuc.co.jp>

FANUC America Corporation
1800 Lakewood Boulevard,
Hoffman Estates, Illinois 60192, U.S.A
<http://www.fanucamerica.com/>

FANUC Europe Corporation, S.A.
Zone Industrielle, L-6468 Echternach,
Grand-Duché de Luxembourg
<http://www.fanuc.eu/>

BEIJING-FANUC Mechatronics CO., LTD
No.9 Xinxu Road, Shangdi Information Industry Base,
Haidian District, Beijing CHINA 100085
<http://www.bj-fanuc.com.cn/>

KOREA FANUC CORPORATION
101, Wanam-ro(st), Seongsan-gu, Changwon-si,
Gyeongsangnam-do, 642-290 Republic of Korea
<http://www.fkc.co.kr/>

TAIWAN FANUC CORPORATION
No.10, 16th Road, Taichung Industrial Park, Taichung, Taiwan
<http://www.fanuctaiwan.com.tw/>

FANUC INDIA PRIVATE LIMITED
41-A, Electronics City, Bangalore, 560 100, India
<http://www.fanucindia.com/>

• All specifications are subject to change without notice.
• No part of this catalog may be reproduced in any form.
• The products in the FANUC Series 0i-MODEL F listed in this catalog are not subject to Items 2 to 15 in the Attachment to the Foreign Exchange Order of the "Foreign Exchange and Foreign Trade Law" but are subject to Item 16 (catch-all controls).
The export from Japan may be subject to an export license by the government of Japan.
Further, re-export to another country may be subject to the license of the government of the country from where the product is re-exported. Furthermore, the product may also be controlled by re-export regulations of the United States government.
Should you wish to export or re-export these products, please contact FANUC for advice.